

**PREDL**

Schutzvermerk nach DIN 34 beachten

## Sanierungsschacht DN900

M 1:15

30.09.16 Miene

A-A

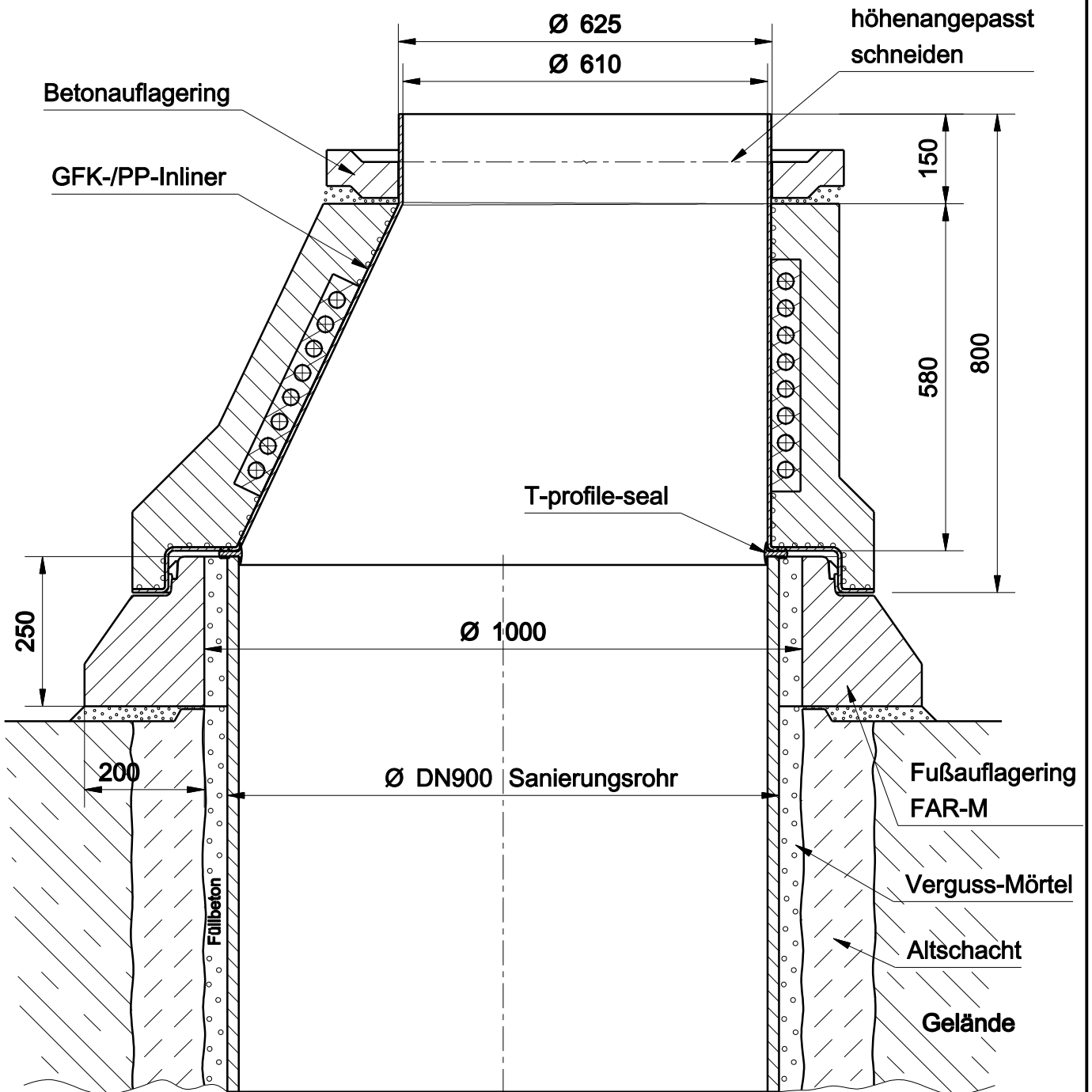

**PREDL**

Schutzvermerk nach DIN 34 beachten

Sanierungsschacht DN900  
Konus mit GFK-liner  
für Fußauflagering

M 1:10

30.09.16 Miene

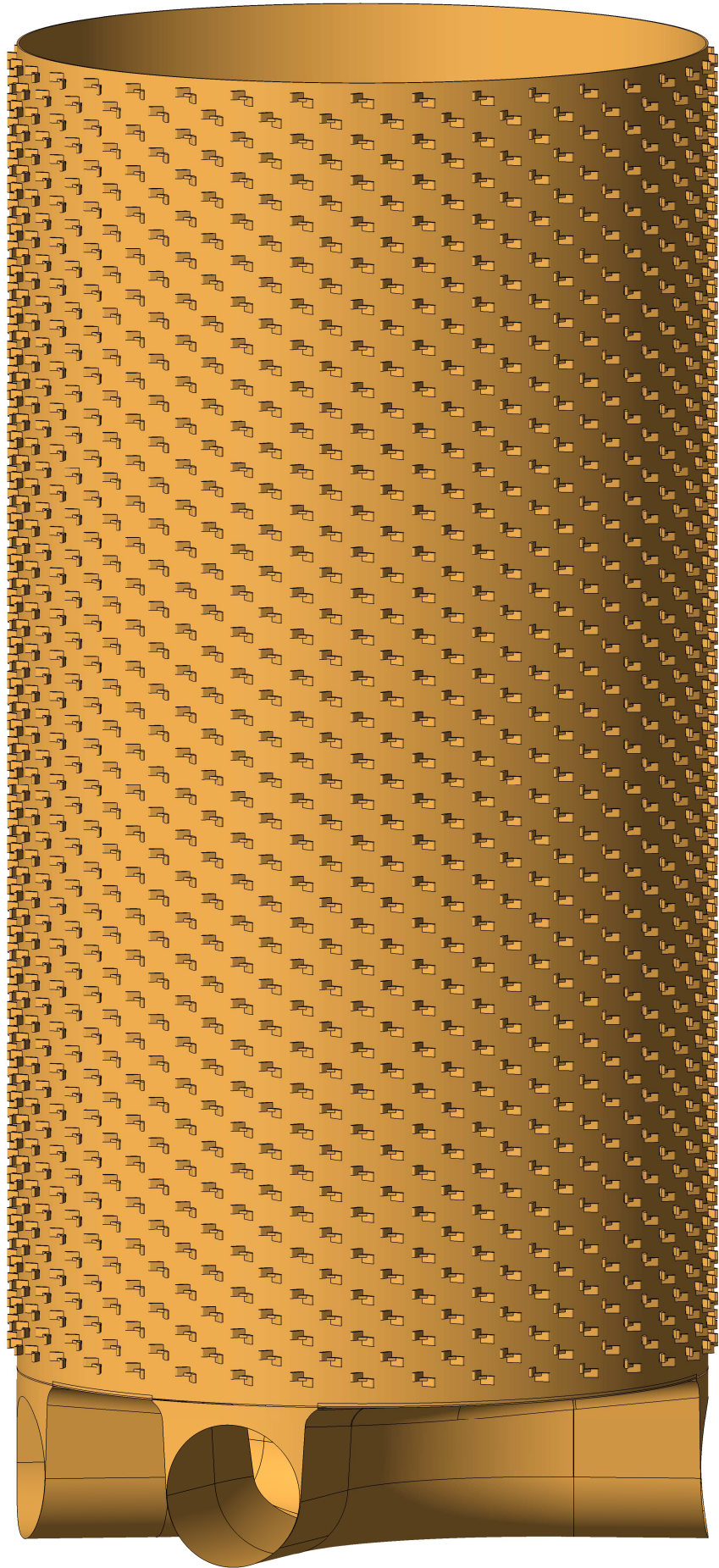

A-A

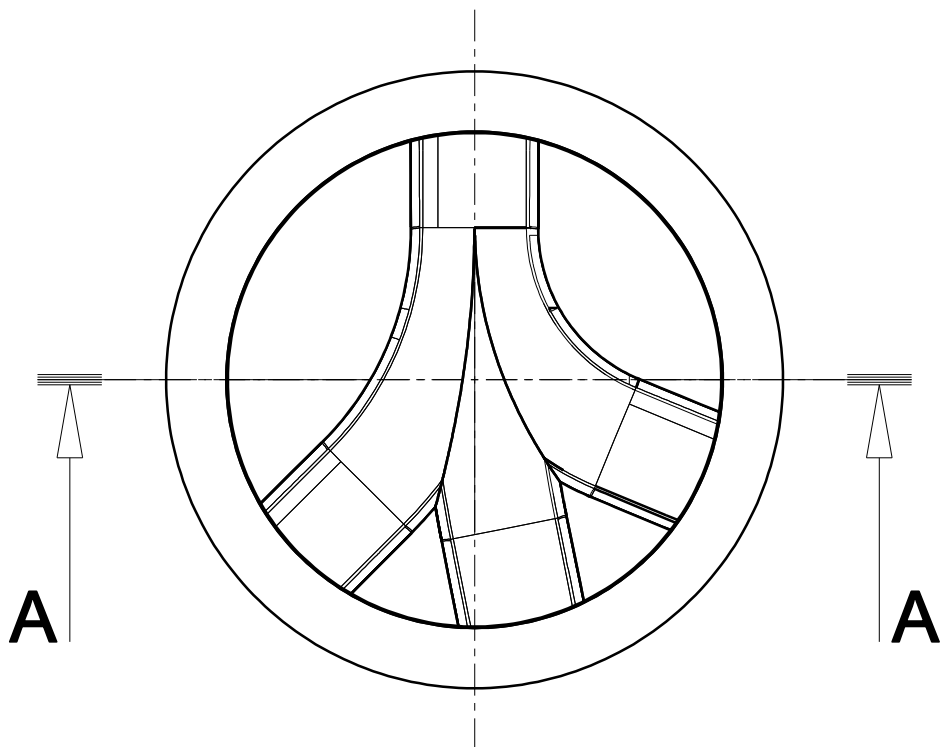
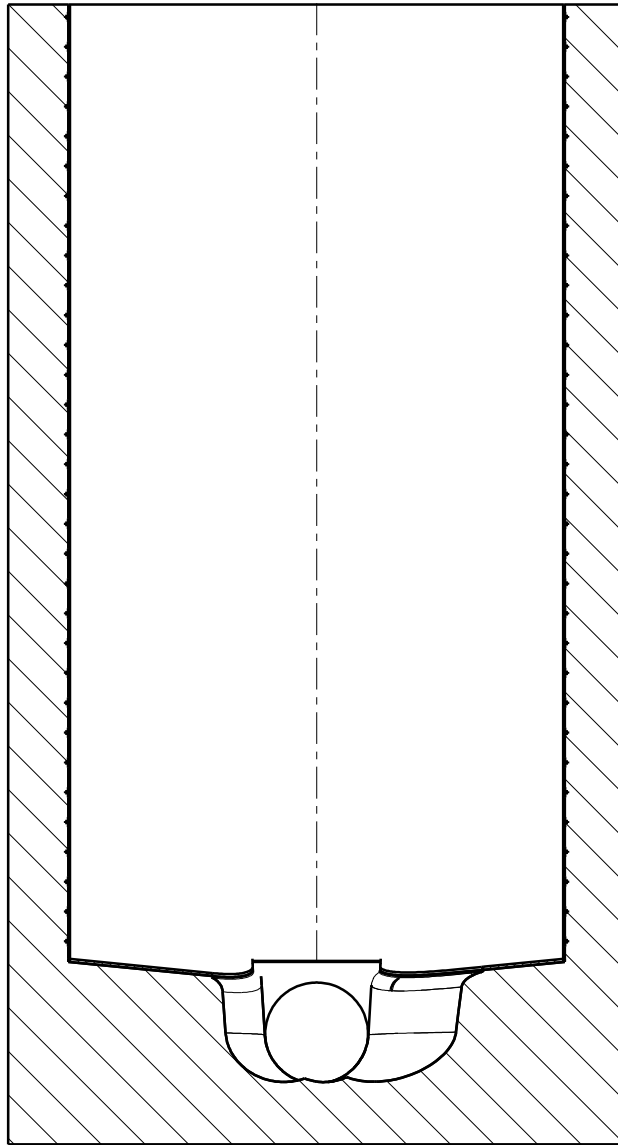

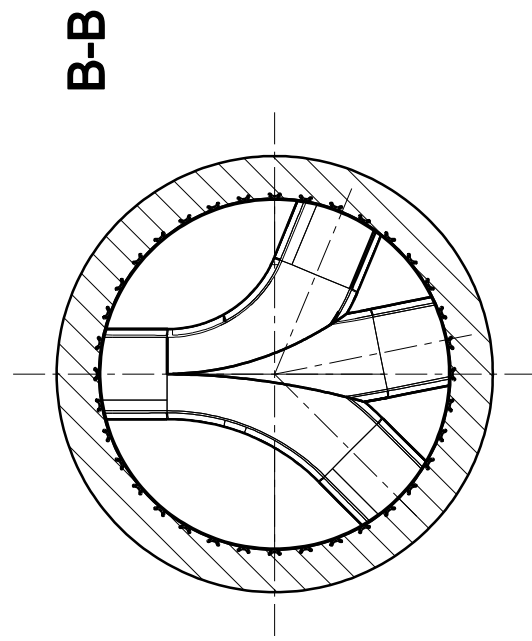
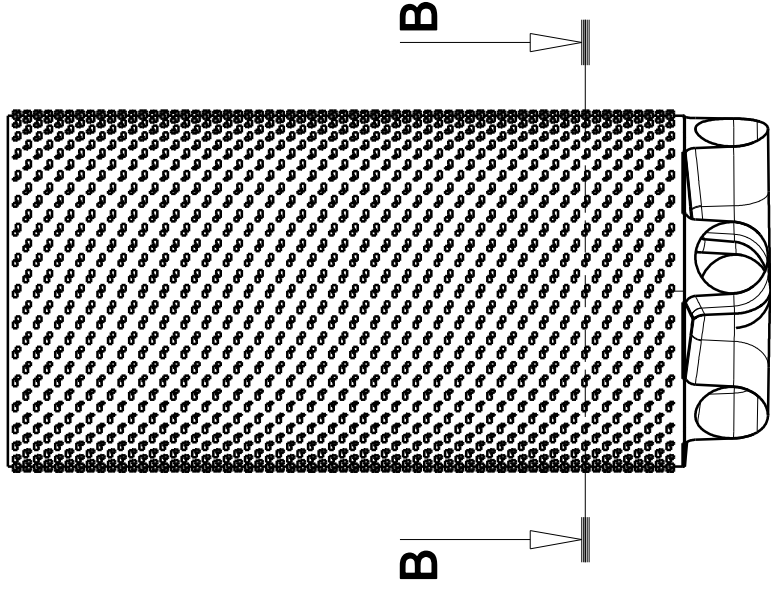
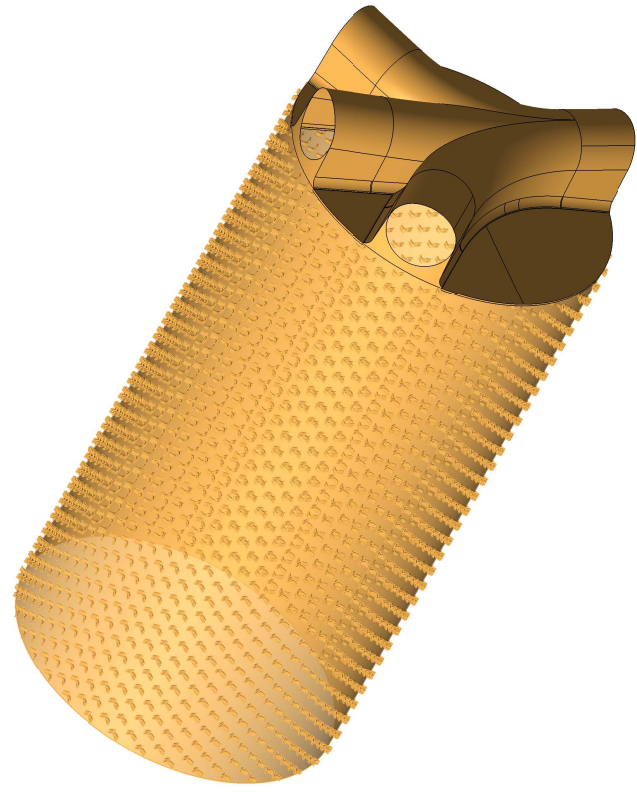

Detail

